

PN-HW861

寸法図

Dimensional Drawing

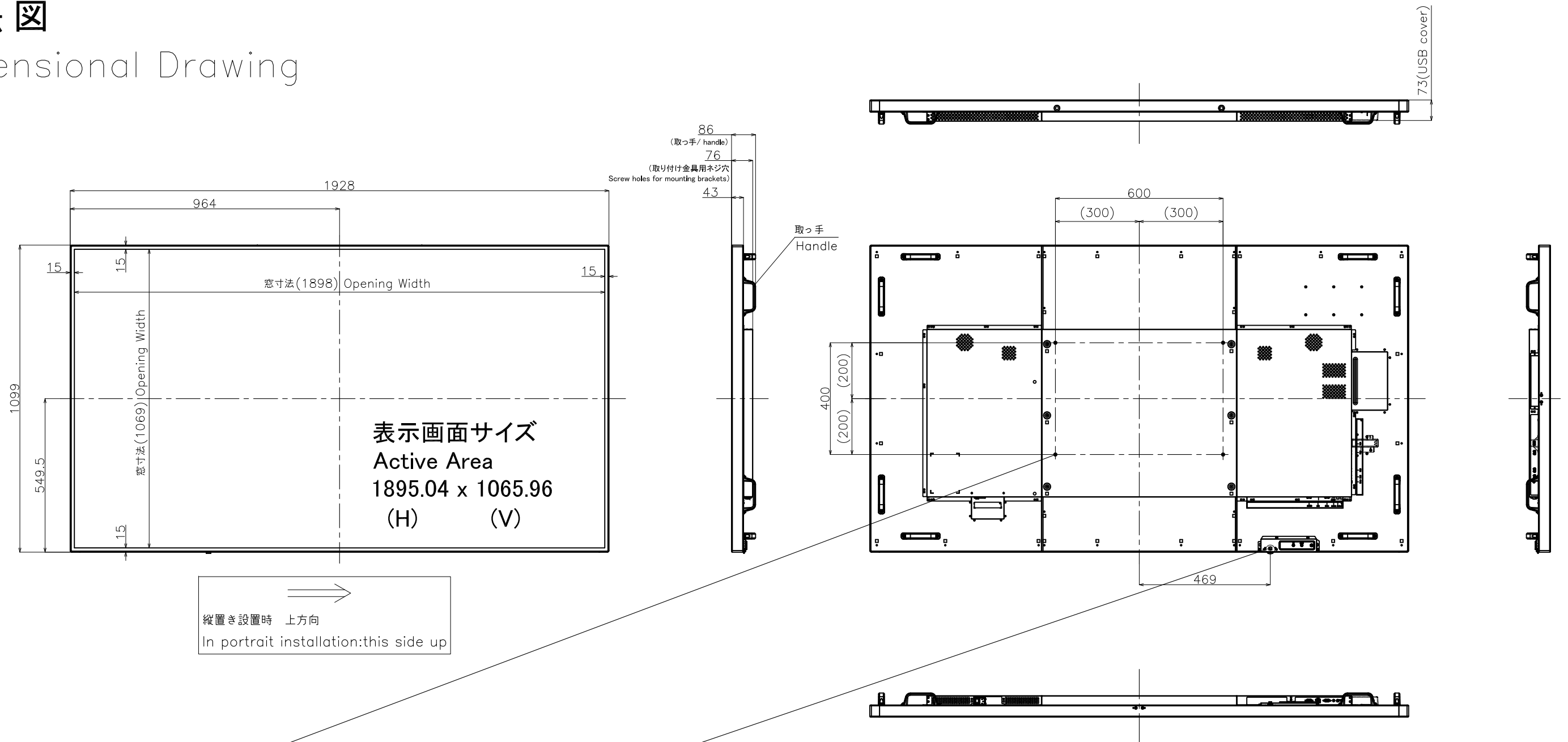

縦置き設置時 上方向
In portrait installation: this side up

4- 取り付け金具用ネジ穴
4- Screw holes for mounting brackets

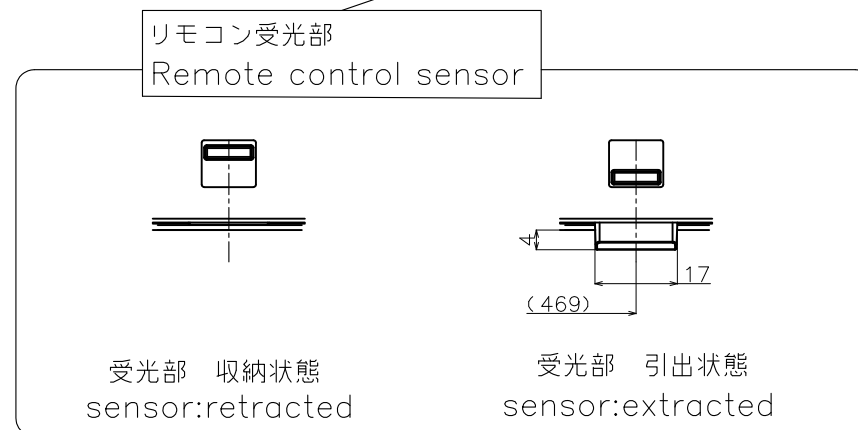
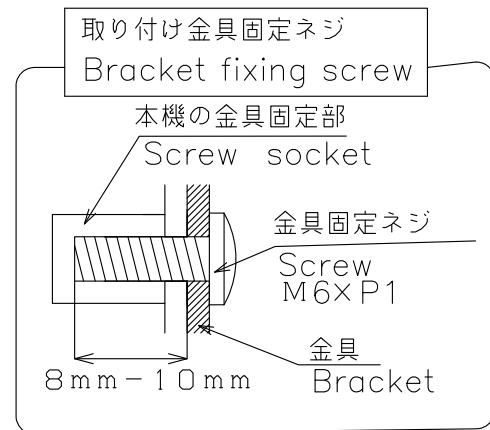

質量	64 kg
Weight	Approx.

単位 : mm
Unit : mm