

PN-HW501

寸法 図

Dimensional Drawing

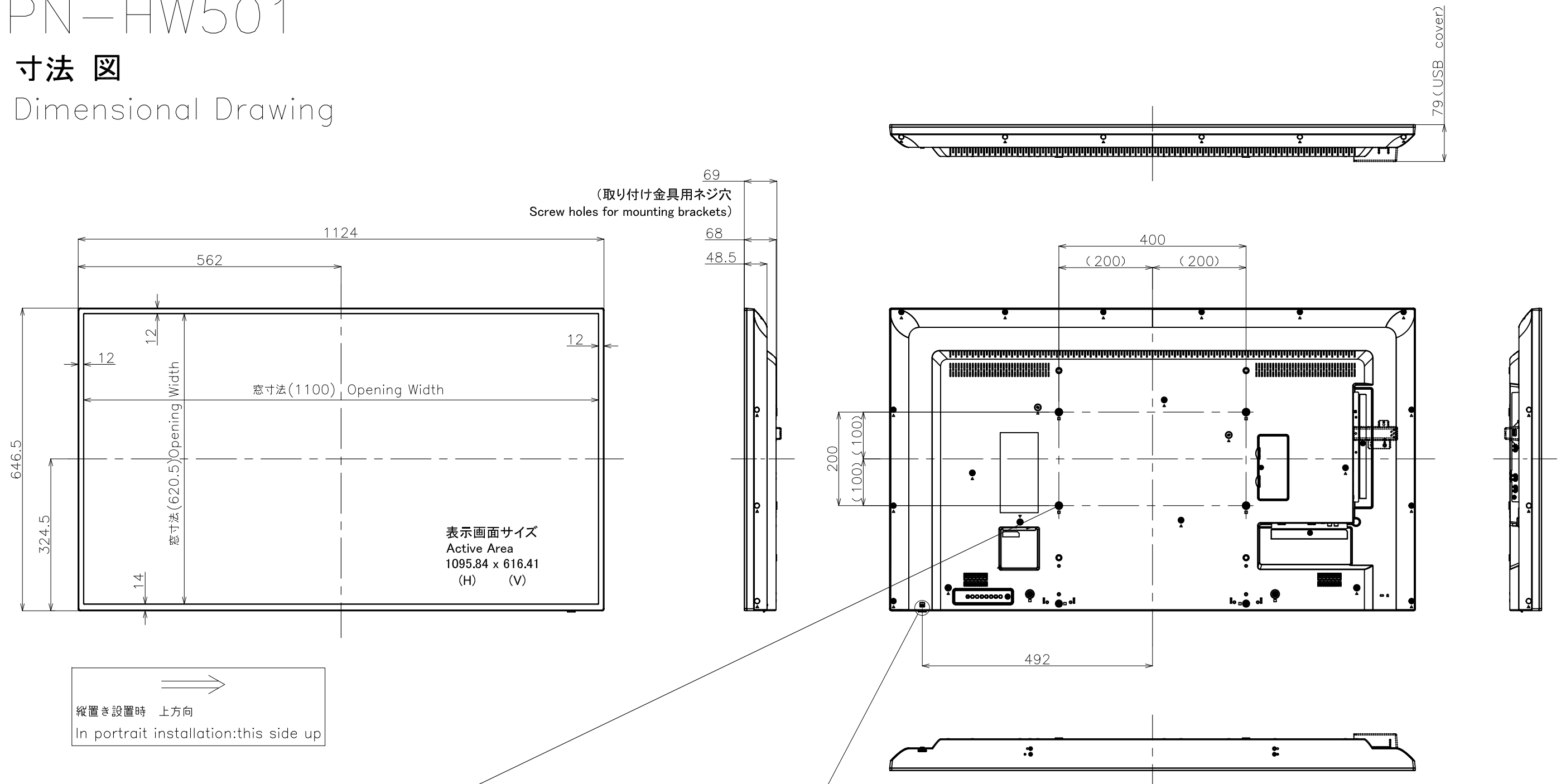

 縦置き設置時 上方向
 In portrait installation: this side up

4- 取り付け金具用ネジ穴
 4- Screw holes for mounting brackets

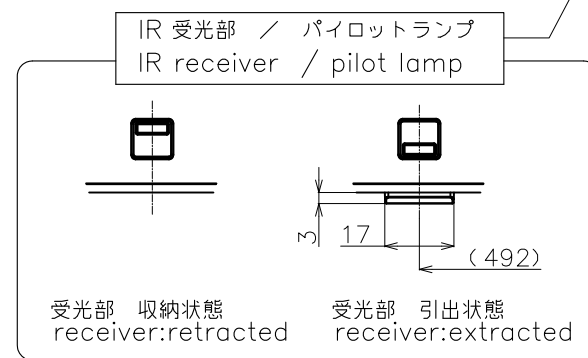
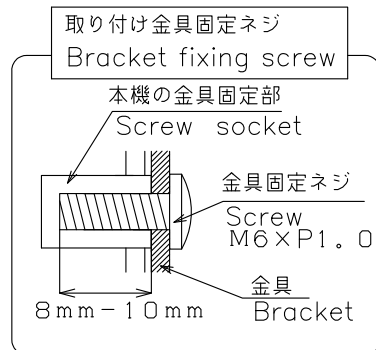

質量	13 kg
Weight	Approx.

単位 : mm
 Unit : mm