

シャープ製LED照明器具 配光データシート 形名 DL-MK200N+DL-M200N

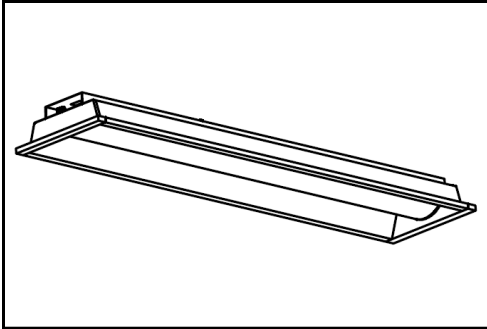

器具光束	2,300 lm
上方光束	2 lm
下方光束	2,298 lm
最大光度	789 cd

光源	LEDライトモジュール
光源型名	DL-M200N
口金形式	-
色温度	5000K
保守率	良:0.86, 中:0.81, 否:0.72
最大取付間隔	a-a 1.4H b-b 1.4H
備考	

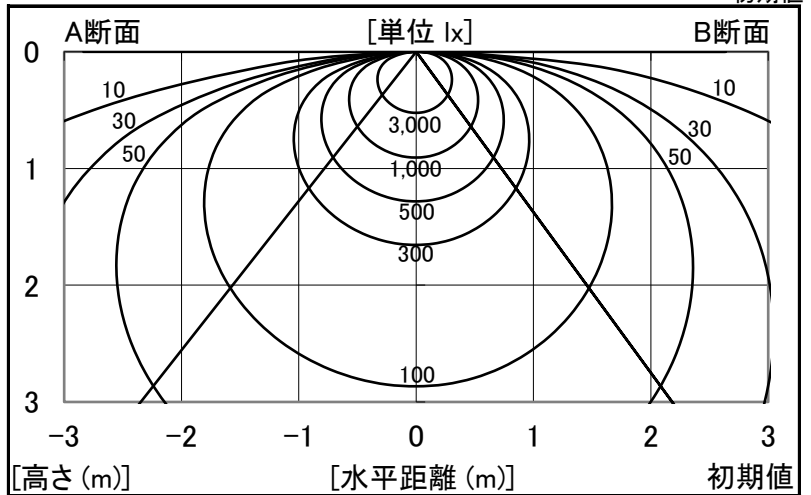

角度	光度 [cd/1,000lm]		
	A-A'	B-B'	C-C'
0	343	343	-
10	338	336	-
20	323	316	-
30	300	285	-
40	269	245	-
50	228	197	-
60	176	144	-
70	111	88	-
80	30	33	-
90	0	0	-
100	0	0	-
110	0	0	-
120	0	0	-
130	0	0	-
140	0	0	-
150	0	0	-
160	0	0	-
170	0	0	-
180	0	0	-

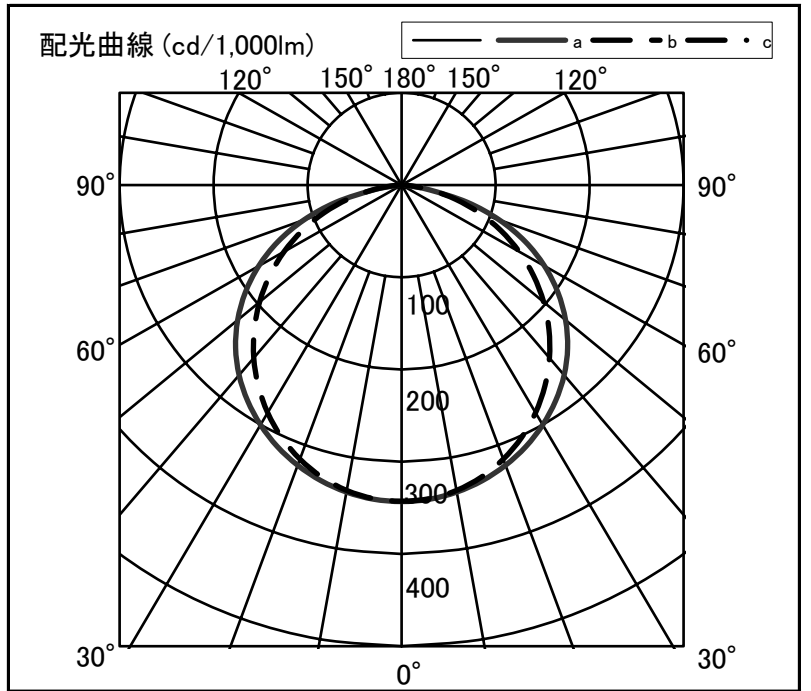

反射率	天井						70						50						30		20		0	
	70		50		30		70		50		30		50		30		30		10		0			
室指数	照明率 (×0.01)																							
0.6	60	56	45	43	36	35	58	54	44	42	36	35	43	41	35	34	34	33	29	27				
0.8	72	65	57	54	47	45	69	64	56	53	47	45	53	51	45	44	44	43	38	36				
1.0	80	72	65	61	56	53	77	70	64	60	55	52	61	58	53	51	51	50	45	42				
1.25	88	78	74	68	64	60	84	76	72	66	63	59	68	64	60	58	58	56	52	49				
1.5	93	82	80	73	70	65	89	80	78	71	69	65	73	69	66	63	63	61	57	54				
2.0	101	88	89	80	80	73	97	85	86	78	78	72	81	76	75	70	71	69	64	61				
2.5	106	91	95	84	87	78	101	89	92	83	85	77	86	80	80	75	76	73	69	67				
3.0	109	94	100	88	92	82	105	92	97	86	90	81	90	83	85	79	80	77	73	70				
4.0	114	97	106	92	100	88	109	95	103	90	97	86	96	87	91	84	86	82	78	76				
5.0	117	99	110	95	105	91	112	97	106	93	101	90	99	90	95	87	89	85	82	79				
7.0	120	101	115	98	111	95	115	99	111	97	107	94	103	93	100	91	94	89	86	83				
10	123	103	119	101	116	99	118	101	115	99	112	97	106	96	104	94	97	92	89	86				