

シャープ製LED照明器具 配光データシート 形名 DL-D063LW

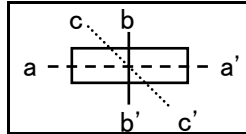

器具光束	2,020 lm
上方光束	0 lm
下方光束	2,020 lm
最大光度	1,338 cd
初期値	

光源	LED
形式	ダウンライト
埋込穴径	Φ150
色温度	3000K
保守率	良:0.88 中:0.86 否:0.81
最大取付間隔	a-a 1.4H
備考	適合電源 DL-YP101

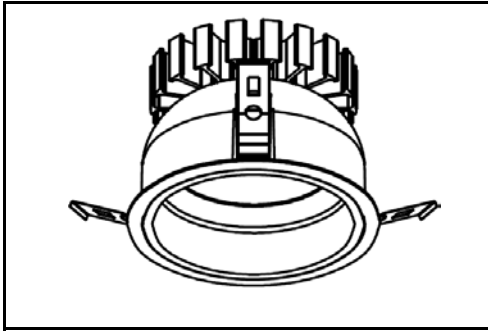
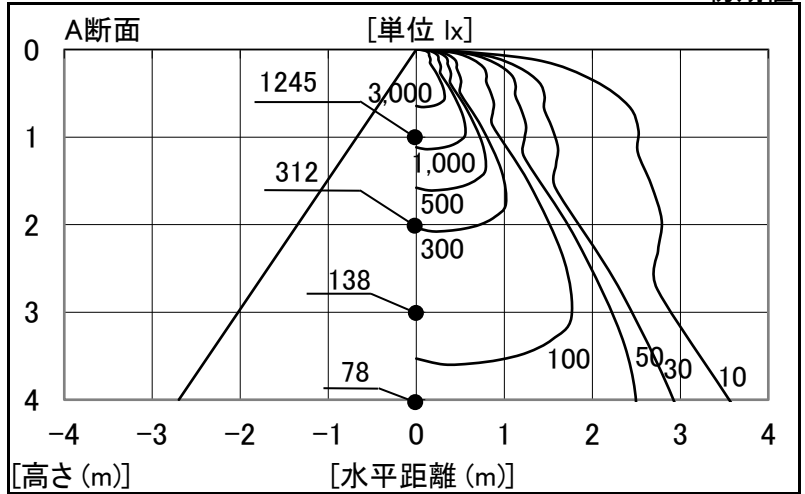

角度	光度[cd/1,000lm]		
	A-A'	B-B'	C-C'
0	608	-	-
10	647	-	-
20	662	-	-
30	607	-	-
40	194	-	-
50	63	-	-
60	46	-	-
70	35	-	-
80	20	-	-
90	0	-	-
100	0	-	-
110	0	-	-
120	0	-	-
130	0	-	-
140	0	-	-
150	0	-	-
160	0	-	-
170	0	-	-
180	0	-	-

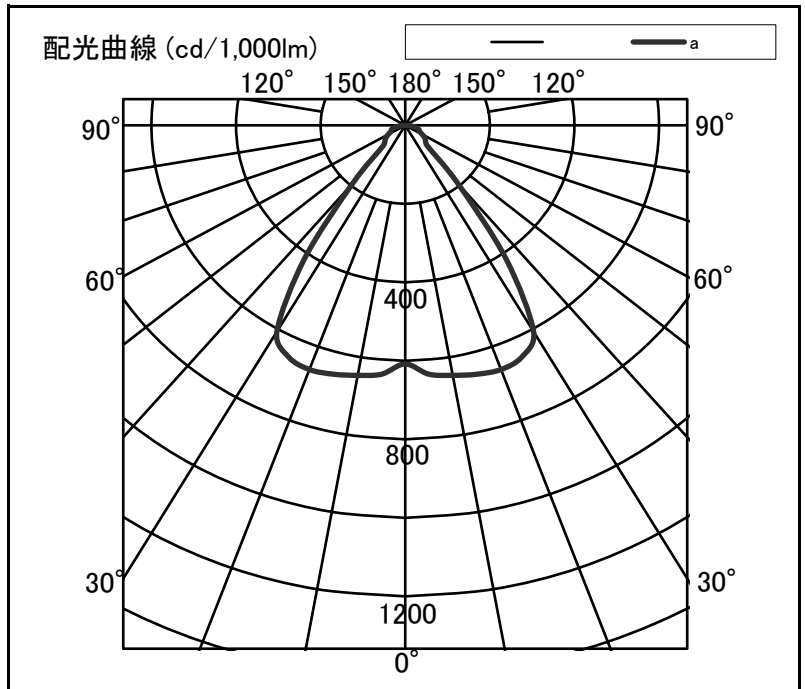

反射率	天井						70						50						30		20		0	
	壁		70		50		30		70		50		30		50		30		30		10		0	
床	30	10	30	10	30	10	30	10	30	10	30	10	30	10	30	10	30	10	30	10	10	0	10	0
室指数	照明率(×0.01)																							
0.6	82	75	71	67	64	62	80	74	70	67	64	62	69	66	63	62	62	61	58	57				
0.8	91	83	81	76	74	71	89	82	80	75	73	70	78	74	72	70	71	69	66	65				
1.0	98	88	87	81	80	76	95	87	86	81	80	76	84	79	78	75	77	75	72	70				
1.25	103	92	94	86	87	81	101	91	92	85	86	81	89	84	84	80	82	79	76	75				
1.5	107	94	98	89	91	85	104	93	96	88	90	84	93	87	88	83	85	82	80	78				
2.0	112	98	105	93	98	90	109	97	102	93	97	89	98	91	93	88	90	87	84	83				
2.5	116	100	109	96	103	93	112	99	106	95	101	92	101	93	97	91	93	90	87	86				
3.0	118	101	112	98	107	95	114	100	109	97	104	95	104	95	100	93	96	92	89	88				
4.0	121	103	116	101	112	98	117	102	113	100	109	97	107	98	104	96	99	94	92	91				
5.0	123	104	119	102	115	100	119	103	115	101	112	99	109	99	106	98	101	96	94	92				
7.0	126	106	122	104	119	103	121	104	118	103	116	102	111	101	109	100	103	98	96	94				
10	127	107	125	105	123	104	123	105	121	104	119	103	113	102	112	101	105	99	98	96				