

シャープ製LED照明器具 配光データシート 形名 DL-D053N

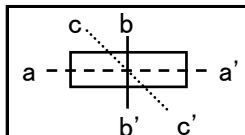
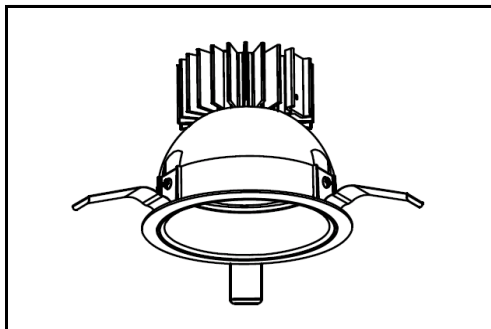

器具光束	2,480 lm
上方光束	0 lm
下方光束	2,480 lm
最大光度	2,598 cd

初期値

光源	LED
形式	ダウンライト
埋込穴径	Φ125
色温度	5000K
保守率	良:0.76 中:0.72 否:0.64
最大取付間隔	a-a 0.93H
備考	

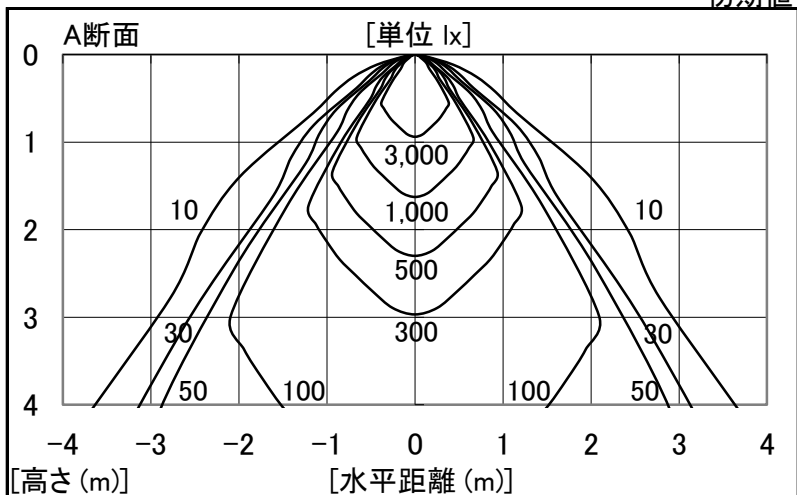

角度	光度[cd/1,000lm]		
	A-A'	B-B'	C-C'
0	1048	-	-
10	899	-	-
20	739	-	-
30	598	-	-
40	202	-	-
50	39	-	-
60	5	-	-
70	0	-	-
80	0	-	-
90	0	-	-
100	0	-	-
110	0	-	-
120	0	-	-
130	0	-	-
140	0	-	-
150	0	-	-
160	0	-	-
170	0	-	-
180	0	-	-

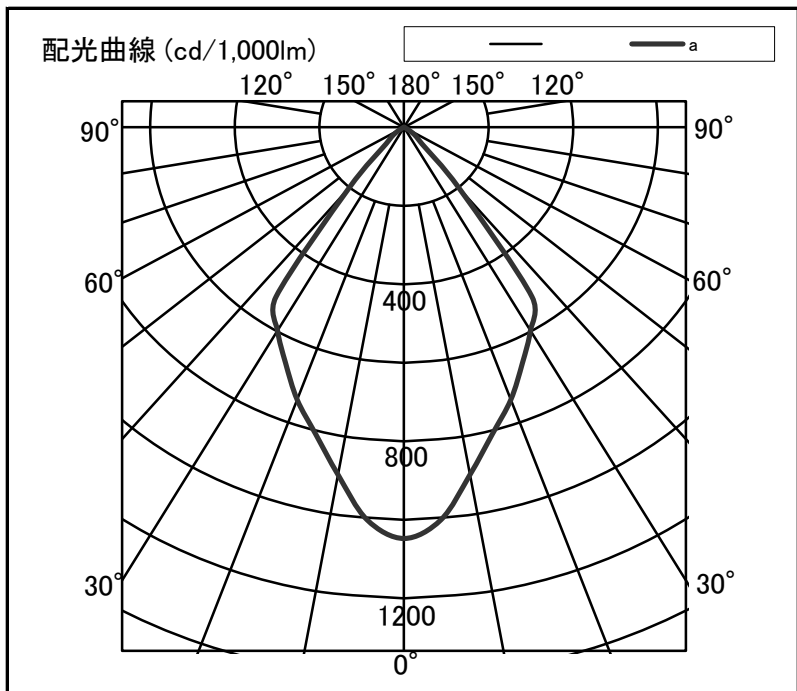

反射率	天井		80		70		50		30		20		0							
	壁	床	70	50	30	70	50	30	50	30	30	10	0							
室指数	照明率(×0.01)																			
0.6	88	81	78	74	72	70	87	80	78	74	72	70	76	73	71	70	71	69	67	66
0.8	97	89	88	83	82	79	96	88	87	82	81	78	85	81	80	78	79	77	75	74
1.0	103	93	95	88	89	84	101	92	93	87	88	84	91	86	86	83	85	83	80	79
1.25	108	96	100	92	94	89	106	95	99	91	93	88	96	90	91	87	89	87	84	83
1.5	112	98	104	95	99	91	109	97	102	94	97	91	99	93	95	90	92	89	87	86
2.0	116	101	110	98	105	95	113	100	107	97	103	95	103	96	99	94	96	93	91	89
2.5	119	103	113	100	109	98	116	102	111	99	107	97	106	98	102	96	99	95	93	91
3.0	121	104	116	101	112	100	117	103	113	101	109	99	107	99	105	97	100	96	94	93
4.0	124	105	119	103	116	102	120	104	116	102	113	101	110	101	107	99	103	98	96	95
5.0	125	106	122	104	119	103	121	105	118	103	115	102	111	101	109	100	104	99	97	96
7.0	127	107	124	106	122	105	123	106	120	105	118	104	113	103	112	102	106	100	99	97
10	128	107	126	107	125	106	124	106	122	105	121	105	114	103	113	103	107	101	100	98