

シャープ製LED照明器具 配光データシート 形名 DL-D052N

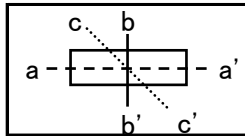
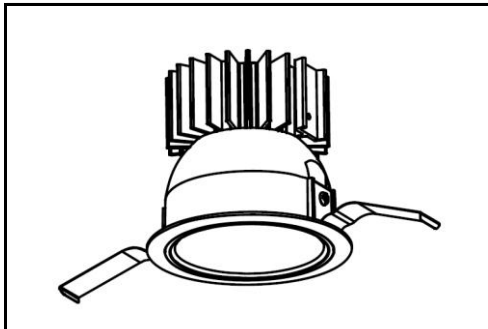

器具光束	1,550 lm
上方光束	0 lm
下方光束	1,550 lm
最大光度	1,836 cd

初期値

光源	LED
形式	ダウンライト
埋込穴径	Φ100
色温度	5000K
保守率	良:0.81 中:0.77 否:0.68
最大取付間隔	a-a 1.1H
備考	

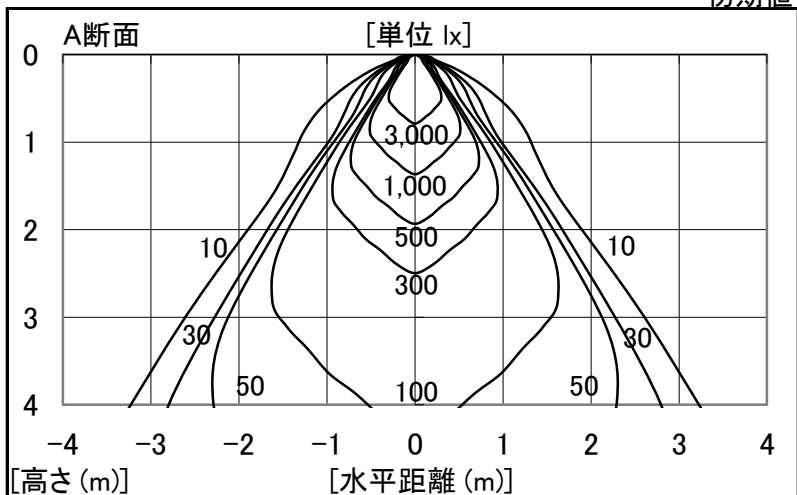

角度	光度[cd/1,000lm]		
	A-A'	B-B'	C-C'
0	1184	-	-
10	977	-	-
20	809	-	-
30	665	-	-
40	125	-	-
50	17	-	-
60	6	-	-
70	0	-	-
80	0	-	-
90	0	-	-
100	0	-	-
110	0	-	-
120	0	-	-
130	0	-	-
140	0	-	-
150	0	-	-
160	0	-	-
170	0	-	-
180	0	-	-

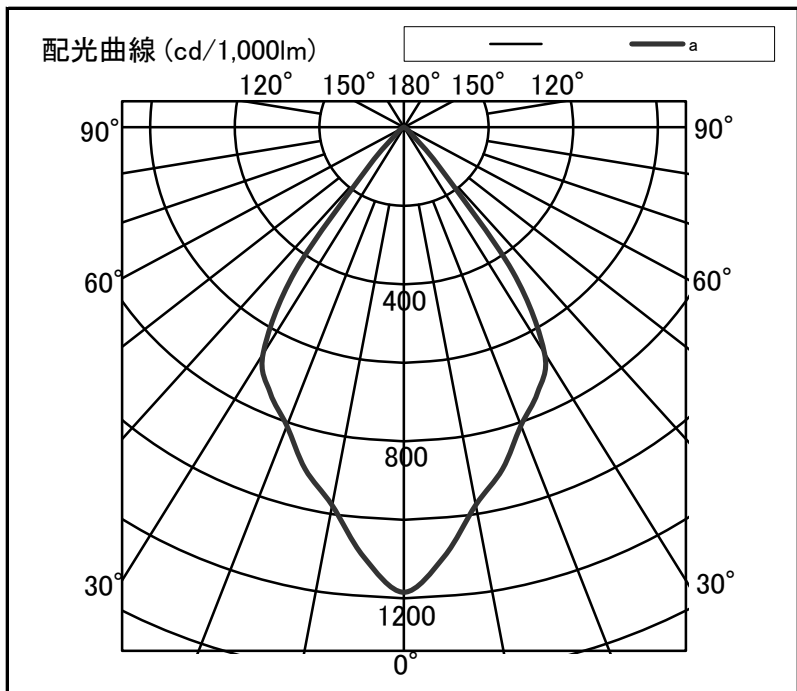

反射率	天井		80		70		50		30		20		0							
	壁	床	70	50	30	70	50	30	50	30	30	10	0							
室指数	照明率(×0.01)																			
0.6	92	85	83	79	78	75	91	84	82	79	77	75	81	78	77	75	76	75	72	71
0.8	100	91	92	86	86	83	99	90	91	86	85	82	89	85	84	82	83	81	79	78
1.0	106	95	97	90	92	87	104	94	96	90	91	87	94	89	89	86	88	86	84	83
1.25	110	98	102	94	97	91	108	97	101	93	96	91	98	92	94	90	92	89	87	86
1.5	113	100	106	96	101	93	110	99	104	96	99	93	101	94	97	92	94	91	89	88
2.0	117	102	111	99	106	97	114	101	109	98	104	96	104	97	101	95	98	94	92	91
2.5	120	103	114	101	110	99	116	102	112	100	108	98	107	99	104	97	100	96	94	93
3.0	122	104	117	102	113	100	118	103	114	101	110	100	108	100	106	98	101	97	95	94
4.0	124	105	120	104	117	102	120	104	117	103	114	102	110	101	108	100	103	99	97	96
5.0	125	106	122	105	119	104	121	105	118	104	116	103	112	102	110	101	105	99	98	96
7.0	127	107	125	106	122	105	123	106	121	105	119	104	113	103	112	102	106	100	99	97
10	128	107	126	107	125	106	124	106	122	106	121	105	115	104	114	103	107	101	100	98